

Constant Current & Constant Voltage LED Power Supply



Product description:

This series was designed for compromise between an attractive price and high performance, which meets SELV standard of preventing electric shock. Protection of open circuit, short circuit, over load and over temperature increased safety in processing. Low standby power consumption complies with ERP directives. Optimized electric circuit design brings cost-effectiveness.



Standards:

EN61347-1 UL8750
 EN61347-2-13 UL1310
 EN61547
 EN55015
 EN61000-3-2
 EN61000-3-3
 EN62384

Characteristics:

- Universal input voltage (100-240Vac)
- Compact dimensions
- Independent use design
- Compatible with constant current and constant voltage function (350mA and 700mA model)
- SELV output (<60V)
- Class 2 output
- Low output ripple current $\pm \leq 15\%$
- Fast start-up time $\leq 0.5s$
- No load power consumption $\leq 0.3W$
- Open circuit, short circuit, over load and over temperature protection
- Auto restart after fault conditions removal
- High efficiency 79% (AC230V, full load)
- ECO design, comply with ERP directives

Specifications:

Model		SLT6-350IL-4	SLT6-500IL-4	SLT6-700IL-4	
Output	turn on time(S)	≤0.5	≤0.5	≤0.5	
	output current(mA)	350	500	700	
	CC	output current tolerance ^①	+/-5%	+/-5%	+/-5%
		ripple current(mA)	50(lp-p)	70(lp-p)	90(lp-p)
		working voltage range(V)	3-22	3-12	3-8.4
		Max. output voltage(V)	24	14	12
	CV	output vorage (V)	24	n/a	12
		output voltage tolerance ^①	+/-1.5%	n/a	+/-1.5%
		ripple voltage(mV)	650(Vp-p)	n/a	500(Vp-p)
		working current range(A)	0-0.3	n/a	0-0.5
	dimming interface		No		
dimming range		n/a			
Input	rated supply voltage(Vac)	100-240	100-240	100-240	
	voltage range(Vac)	90-264	90-264	90-264	
	line frequency(Hz)	50/60	50/60	50/60	
	input current(mA)	120	120	120	
	efficiency ^②	76.50%	70.0%	70.0%	
	power factor ^②	0.40C	0.40C	0.40C	
	inrush current(lp-k)	25A/80us	25A/80us	25A/80us	
Protection	over voltage protection	YES	YES	YES	
	short circuit protection	YES	YES	YES	
	over temperature protection	YES	YES	YES	
	automatic restart	YES	YES	YES	
	over load protection	YES	YES	YES	
	surge capacity	L-N: 500V	L-N: 500V	L-N: 500V	
Ambient and Life	Ta(°C)	-20...+50(350/500mA);40(700mA)			
	Tc max.(°C)	75(350/500mA);70(700mA)			
	Storage Temperature(°C)	-30...80			
	ambient humidity range	5%...85%RH, Not condensing			
	nominal life-time(hrs)	30'000@Tc=75 C			
Other	weight(g)	37.5			
	dimensions (LxWxH)(mm)	68x35x20			
	casing material	Plastic			
	housing colour	White			
	type of protection	IP20			
	protection class	CLASS II			
Note	<p>1. Tolerance:includes set up tolerance, line regulation and load regulation. 2. Tested at full load,230Vac.Refer to"Power Factor" and "EFFICIENT"curve graphs. 3. All parameters NOT specially mentioned are measured at nominal voltage input, rated load and 25 of ambient temperature. 4. The power supply is considered as a component that will be operated in combination with final equipment. Since EMC performance will be affected by the complete installation, the final equipment manufacturers must re-qualify EMC Directive on the complete installation again."</p>				

Dimensions(mm/inches):

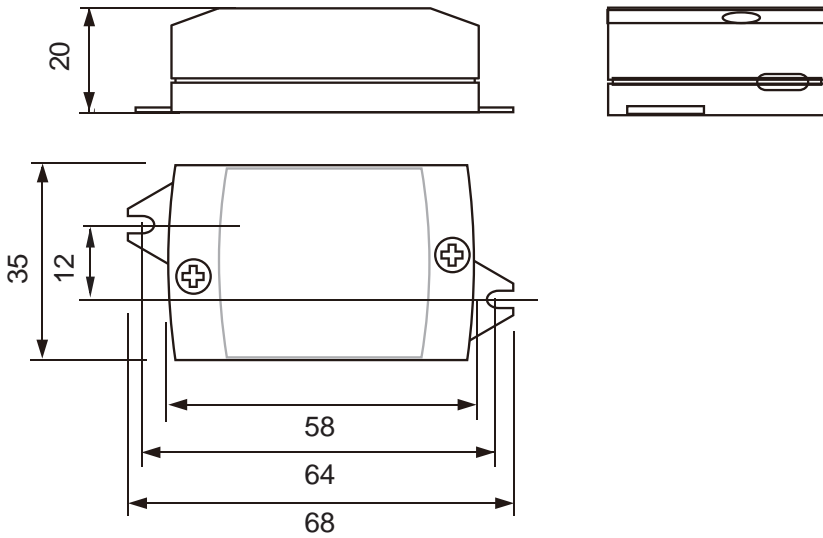

Wiring diagram:

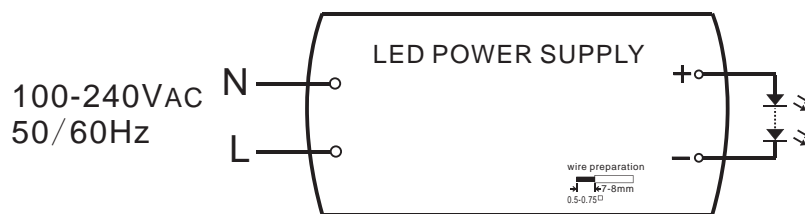

Electrical curves:

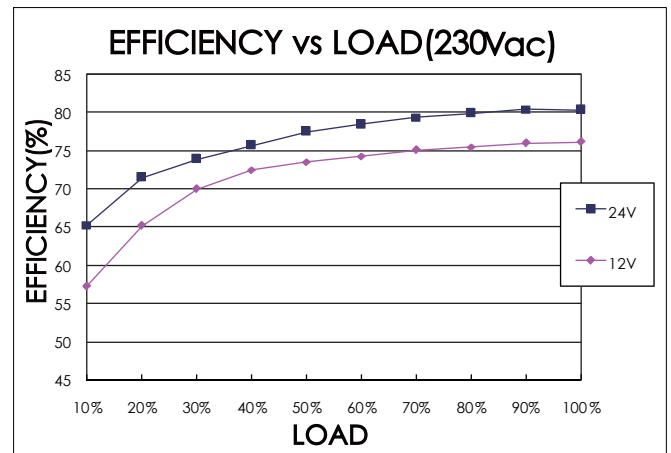
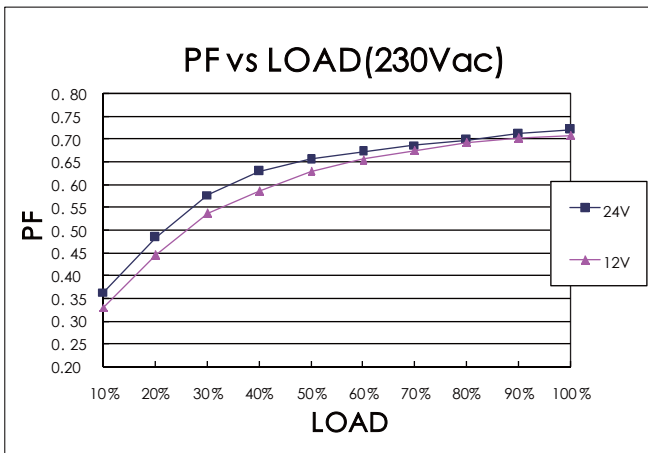
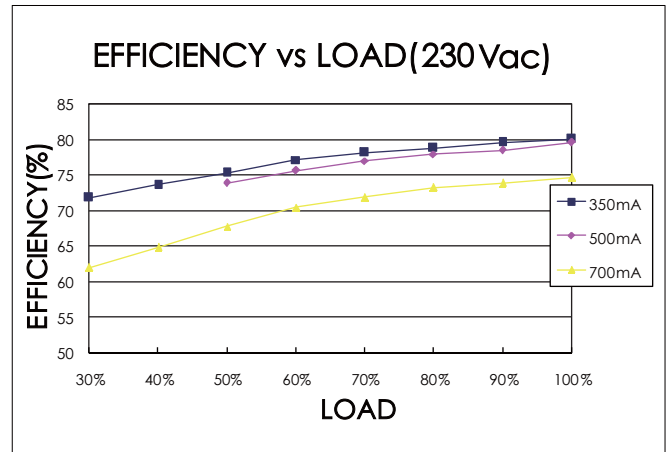
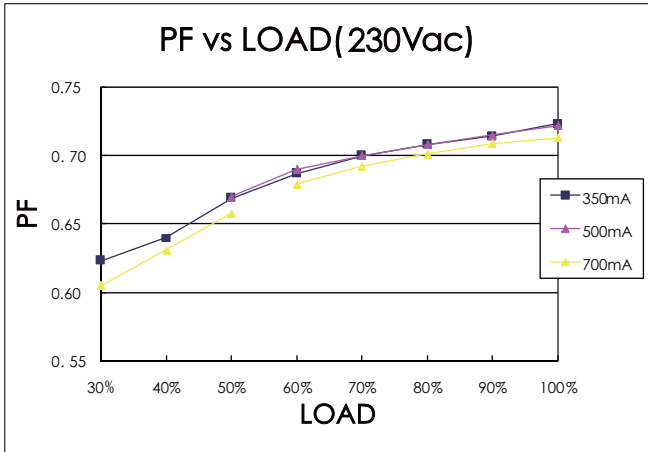

Electrical curves:

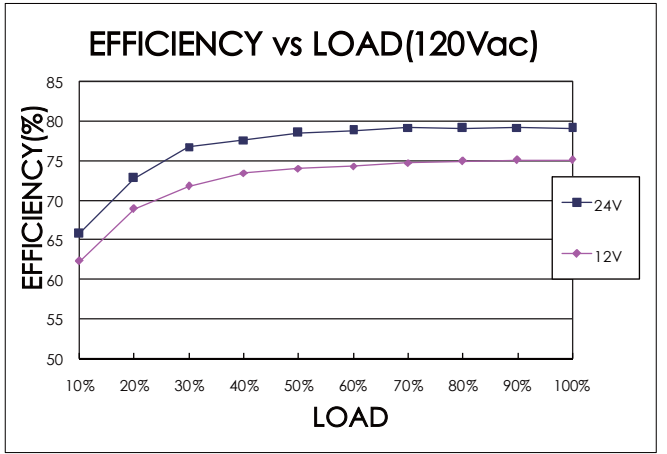
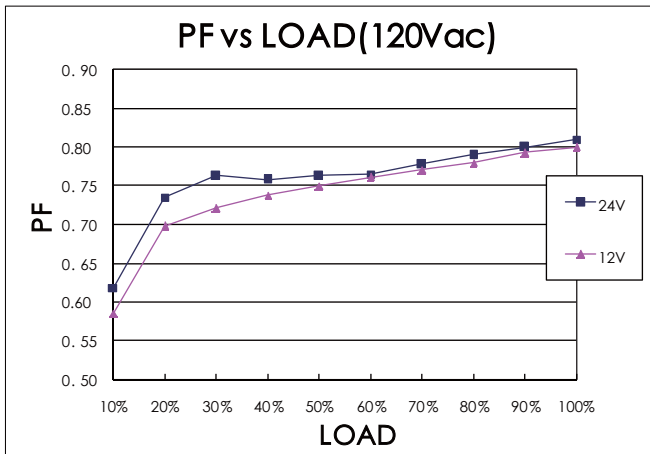
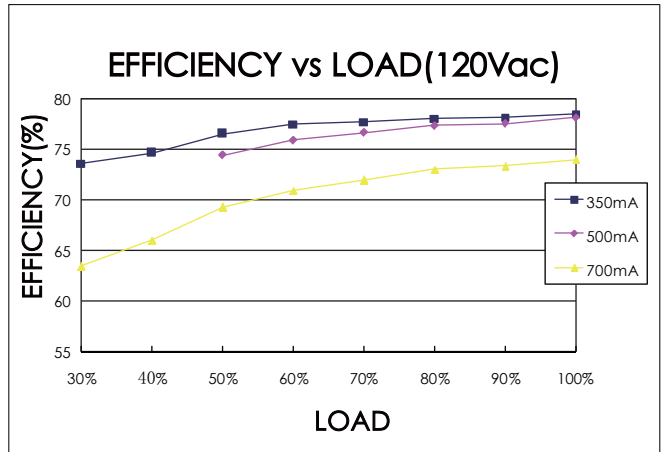
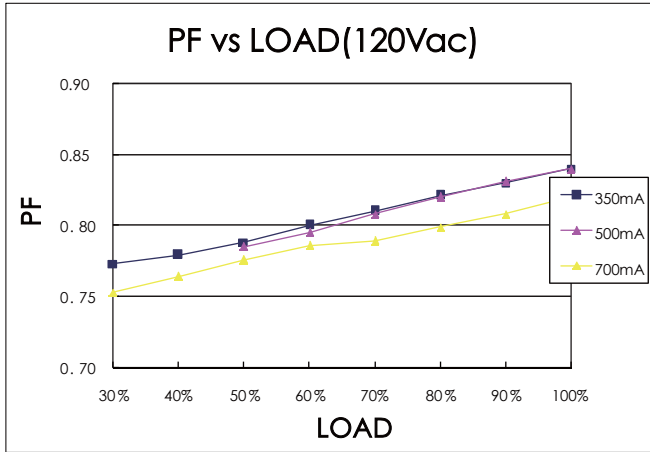

note
 For constant current power supply,"LOAD" means the percentage of the maximum rated output voltage.
 For constant voltage power supply,"LOAD" means the percentage of the maximum rated output current.

Sales & Technical Support:

Self Electronics Co.,Ltd.

Add: No. 1345 Ju Xian Road, Ningbo Hi Tech Park, Ningbo, China

Tel: 0086-574-28805765,28805658(For English Assistance)

0086-574-28805678 (For Chinese Assistance)

Fax: 0086-574-28805656

E-mail: sales@self-ecg.com

<http://www.self-ecg.com>

Self Electronics Co.,Ltd.,Shenzhen Office

Add: Room2007,Xinglang Xuan,Xinghe Mingju,Fuming Road,Futian District,Shenzhen

Tel: 0086-755-83558850, 83558851

Fax: 0086-755-83558840

SELF ELECTRONICS FRANCE BRANCH OFFICE

Add:12-14 rue Raymond Ridel, 92250 La Garennes Colombes

Tel: 0033 (0)1 72 42 71 57

E-mail: saleseu@self-electronics.com

SELF ELECTRONICS GERMANY GMBH

Add:August-Horch-Str. 7,51149 Koeln

Tel: 0049 2203 18501-0

Fax: 0049 2203 18501-199

E-mail: saleseu@self-electronics.com

*Due to continuous improvements and innovations,specifications are subjected to change without notice.